

ENCO

Apparecchio per illuminazione di esterni costituito da:

- Palo in alluminio estruso verniciato
- Struttura superiore in alluminio pressofuso verniciato
- Diffusore in policarbonato
- Parabola riflettente in alluminio
- Guarnizione in silicone
- Viti di chiusura in acciaio inox
- Verniciatura in polveri poliestere ad elevata resistenza ai raggi ultravioletti e alla corrosione

Outdoor luminaire constructed of:

- Painted extruded aluminium post
- Painted die-cast aluminium head
- Polycarbonate diffuser
- Aluminium reflector
- Silicon gasket
- Stainless steel screws
- Painting using high resistance to UV and corrosion polyester powders



Colori - Colours

X=2 Bianco
White

X=3 Nero
Black

X=9 Antracite
Anthracite

X=4 Silver

Diffusore - Diffuser

Codice-Code 08 4080

Le lampadine vengono fornite solo su richiesta

Bulbs supplied only on request

Classe energetica : vedi pag. 370
Energy class : see page 370

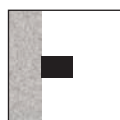

4080
Installazione a parete
Wall mounting



4082 - 4084
4086 - 4088
Installazione a terra
Floor mounting

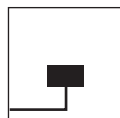

Entrata singola
cavi di alimentazione
Single power supply
cables input

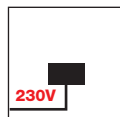

LED
Led a tensione di rete 220/240V 50/60Hz.
Connessione diretta alla rete di alimentazione
senza necessità di trasformatore.
LED's direct operation at 220/240V 50/60Hz.
No transformer is required.

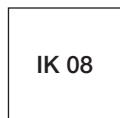

IK 08





4080

4080.00X		A60	75W	E27
4080.95X		TC-D	26W	G24 d-3
4080.55X		LED	8,7W	800 lm 4000 K
4080.56X		LED	8,7W	780 lm 3000 K

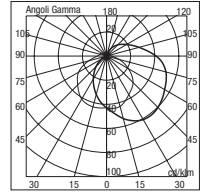
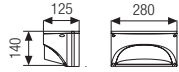

4080 95



4086 H 700
4082 H 1100

4086.00X		A60	75W	E27
4086.95X		TC-D	26W	G24 d-3
4086.81X		TC-TEL	26-32-42W	GX24 q-3-4

Con reattore elettronico / With electronic ballast

4086.55X		LED	8,7W	800 lm 4000 K
4086.56X		LED	8,7W	780 lm 3000 K

4082.00X		A60	75W	E27
4082.95X		TC-D	26W	G24 d-3
4082.81X		TC-TEL	26-32-42W	GX24 q-3-4

Con reattore elettronico / With electronic ballast

4082.55X		LED	8,7W	800 lm 4000 K
4082.56X		LED	8,7W	780 lm 3000 K

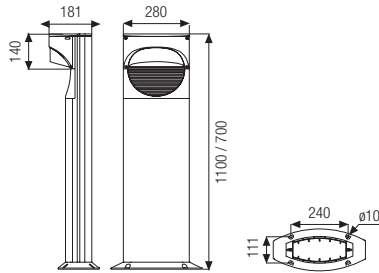

ENCO STELO

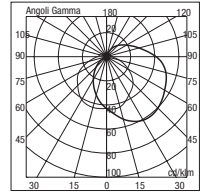

4086 95

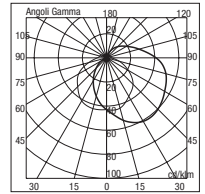

4082 95



4084 H 700 doppia/double
4088 H 1100 doppia/double

4084.00X		A60	2x75W	E27
4084.95X		TC-D	2x26W	G24 d-3
4084.81X		TC-TEL	2x26-32W	GX24 q-3

Con reattore elettronico / With electronic ballast

4088.00X		A60	2x75W	E27
4088.95X		TC-D	2x26W	G24 d-3
4088.81X		TC-TEL	2x26-32W	GX24 q-3

Con reattore elettronico / With electronic ballast

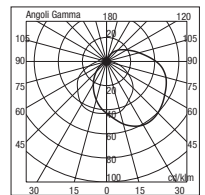
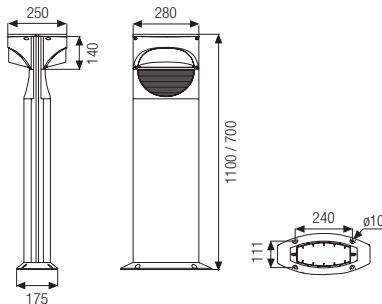

4084 95

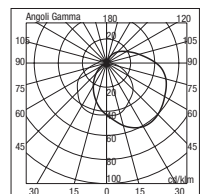

4088 95